

## M4x.22xx-x4 - 8 bit Digitizer up to 5 GS/s

- 5 GS/s on one channel, 2.5 GS/s on two channels
- 1.25 GS/s on four channels
- up to 1.5 GHz bandwidth
- PXIe 3U format, 2 slots wide
- Ultra Fast PCI Express x4 Gen 2 interface
- Simultaneously sampling on all channels
- 4 input ranges:  $\pm 200$  mV up to  $\pm 2.5$  V
- Low voltage input range option  $\pm 40$  mV up to  $\pm 500$  mV
- Programmable input offset of  $\pm 200\%$
- 4 GSamples on-board memory
- Window, re-arm, OR/AND triggerFeatures: Single-Shot, Streaming, Multiple Recording, Gated Sampling, ABA, Timestamps

Speed	SNR	ENOB
5 GS/s	>44.5 dB	>7.1 bit
2.5 GS/s	>45.6 dB	>7.3 bit
1.25 GS/s	>46.9 dB	>7.5 bit

### FPGA Options:

- Block Average up to 128k
- Block Statistics/Peak Detect

**M4x**  
series



- PXIe x4 Gen 2 Interface
- Works with all PXIe and PXI hybrid slots
- Sustained streaming mode more than 1.7 GB/s\*\*

Operating Systems	Recommended Software	Drivers
<ul style="list-style-type: none"> <li>• Windows XP, Vista, 7, 8, 10</li> <li>• Linux Kernel 2.6, 3.x, 4.x</li> <li>• Windows/Linux 32 and 64 bit</li> </ul>	<ul style="list-style-type: none"> <li>• Visual Basic, Visual C++, Borland C++, GNU C++, Borland Delphi, VB.NET, C#, J#, Python</li> <li>• SBench 6</li> </ul>	<ul style="list-style-type: none"> <li>• MATLAB</li> <li>• LabVIEW</li> <li>• LabWindows/CVI</li> <li>• IVI</li> </ul>

Model	Bandwidth	1 channel	2 channels	4 channels
M4x.2234-x4	1.5 GHz	5 GS/s	2.5 GS/s	1.25 GS/s
M4x.2233-x4	1.5 GHz	5 GS/s	2.5 GS/s	
M4x.2230-x4	1.5 GHz	5 GS/s		
M4x.2221-x4	1.5 GHz	2.5 GS/s	2.5 GS/s	
M4x.2223-x4	1.5 GHz	2.5 GS/s	1.25 GS/s	
M4x.2220-x4	1.5 GHz	2.5 GS/s		
M4x.2212-x4	500 MHz	1.25 GS/s	1.25 GS/s	1.25 GS/s
M4x.2211-x4	500 MHz	1.25 GS/s	1.25 GS/s	
M4x.2210-x4	500 MHz	1.25 GS/s		

## General Information

The M4x.22xx-x4 series digitizers deliver the highest performance in both speed and resolution. The series includes PXIe cards with either one, two or four synchronous channels. The ADCs can sample at rates from 1.25 GS/s up to 5 GS/s with a maximum bandwidth of more than 1 GHz.

The PXIe digitizers feature an interface with PCI Express x4 Gen 2 interface that offers outstanding data streaming performance. The interface and Spectrum's optimized drivers enable data transfer rates in excess of 1.7 GB/s so that signals can be acquired, stored and analyzed at the fastest speeds.

While the cards have been designed using the latest technology they are still software compatible with the drivers from earlier Spectrum digitizers starting with M2i series. Existing customers can use the same software they developed for a 10 year old 200 kS/s multi-channel card and for an M4x series 5 GS/s high speed digitizer!

\*\*Throughput measured with a motherboard chipset supporting a TLP size of 256 bytes.

## Software Support

### Windows drivers

The cards are delivered with drivers for Windows XP and Vista (32 bit), as well as Windows 7, Windows 8 and Windows 10 (32 bit and 64 bit). Programming examples for Visual C++, Borland C++ Builder, LabWindows/CVI, Borland Delphi, Visual Basic, VB.NET, C#, J#, Python and IVI are included.

### Linux Drivers



All cards are delivered with full Linux support. Pre compiled kernel modules are included for the most common distributions like RedHat, Fedora, Suse, Ubuntu LTS or Debian. The Linux support includes SMP systems, 32 bit and 64 bit systems, versatile programming examples for Gnu C++ as well as the possibility to get the driver sources for your own compilation.

### SBench 6

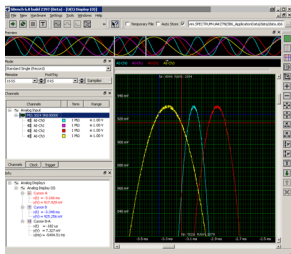

A base license of SBench 6, the easy-to-use graphical operating software for Spectrum cards, is included in the delivery. The base license makes it possible to test the card, display acquired data and make some basic measurements. It's a valuable tool for checking the card's performance and assisting with the unit's initial

setup. The cards also come with a demo license for the SBench 6 professional version. This license gives the user the opportunity to test the additional features of the professional version with their hardware. The professional version contains several advanced measurement functions, such as FFTs and X/Y display, import and export utilities as well as support for all acquisition modes including data streaming. Data streaming allows the cards to continuously acquire data and transfer it directly to the PC RAM or hard disk. SBench 6 has been optimized to handle data files of several GBytes. SBench 6 runs under Windows as well as Linux (KDE, GNOME and Unity) operating systems. A test version of SBench 6 can be downloaded directly over the internet and can run the professional version in a simulation mode without any hardware installed. Existing customers can also request a demo license for the professional version from Spectrum. More details on SBench 6 can be found in the SBench 6 data sheet.

### Third-party products

Spectrum supports the most popular third-party software products such as LabVIEW, MATLAB or LabWindows/CVI. All drivers come with detailed documentation and working examples are included in the delivery. Support for other software packages, like VEE or DasyLab, can also be provided on request.

## Hardware features and options

### PXI Express x4



The M4x series PXI Express cards use a PCI Express x4 Gen 2 connection. They can be used in every PXI Express (PXIe) slot, as well as in any PXI hybrid slot with Gen 1, Gen 2 or Gen 3. The maximum sustained data transfer rate is more than 1.7 GByte/s (read direction) or 1.4 GByte/s (write direction) per slot.

## Connections

- The cards are equipped with SMA connectors for the analog signals as well as for the two external trigger inputs, and clock input and output. In addition, there are three MMCX connectors that are used for the three multi-function I/O connectors. These multi-function connectors can be individually programmed to perform different functions:
- Trigger output
- Status output (armed, triggered, ready, ...)
- Synchronous digital inputs, being stored inside the analog data samples
- Asynchronous I/O lines



### Input Amplifier

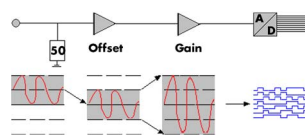

The analog inputs can be adapted to real world signals using a wide variety of settings that are individual for each channel. By using software commands one can select a matching input

range and the signal offset can be compensated by programmable AC coupling or offset shifting.

### Software selectable lowpass filter

Each analog channel contains a software selectable low-pass filter to limit the input bandwidth. Reducing the analog input bandwidth results in a lower total noise and can be useful especially with low voltage input signals.

### Automatic on-board calibration

Every channel of each card is calibrated in the factory before the board is shipped. However, to compensate for environmental variations like PC power supply, temperature and aging the software driver includes routines for automatic offset and gain calibration. This calibration is performed on all input ranges of the "Buffered" path and uses a high precision onboard calibration reference.

### Digital inputs

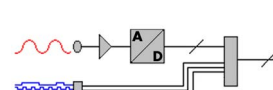

This option acquires additional synchronous digital channels phase-stable with the analog data. A maximum of 3 additional digital inputs are available on the front plate of the card using the multi-purpose I/O lines.

### Ring buffer mode

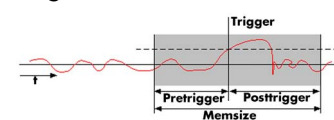

The ring buffer mode is the standard mode of all oscilloscope instruments. Digitized data is continuously written into a ring memory until a trigger event is detected. After the trigger, post-trigger samples are recorded and pre-trigger samples can also be stored. The number of pre-trigger samples available simply equals the total ring memory size minus the number of post trigger samples.

### FIFO mode

The FIFO or streaming mode is designed for continuous data transfer between the digitizer card and the PC memory. When mounted in a PXI Express x4 Gen 2 capable PXIe slot, read streaming speeds of up to 1.7 GByte/s are possible. The control of the data stream is done automatically by the driver on interrupt request basis. The complete installed onboard memory is used to buffer the data, making the continuous streaming process extremely reliable.

### Channel trigger

The digitizers offer a wide variety of trigger modes. These include a standard triggering mode based on a signals level and slope, like

that found in most oscilloscopes. It is also possible to define a window mode, with two trigger levels, that enables triggering when signals enter or exit the window. Each input has its own trigger circuit which can be used to setup conditional triggers based on logical AND/OR patterns. All trigger modes can be combined with a re-arming mode for accurate trigger recognition even on noisy signals.

### External trigger input

All boards can be triggered using up to two external analog or digital signals. One external trigger input has two analog comparators that can define an edge or window trigger, a hysteresis trigger or a rearm trigger. The other input has one comparator that can be used for standard edge and level triggers.

### Multiple Recording

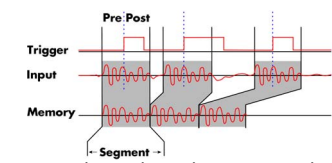

The Multiple Recording mode allows the recording of several trigger events with an extremely short re-arming time. The hardware doesn't need to be restarted in between. The on-board memory is divided in several segments of the same size. Each of them is filled with data if a trigger event occurs. Pre- and posttrigger of the segments can be programmed. The number of acquired segments is only limited by the used memory and is unlimited when using FIFO mode.

### Gated Sampling

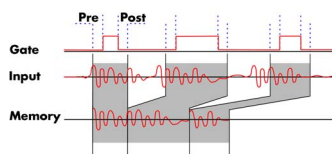

The Gated Sampling mode allows data recording controlled by an external gate signal. Data is only recorded if the gate signal has a programmed level. In addition a pre-area before start

of the gate signal as well as a post area after end of the gate signal can be acquired. The number of gate segments is only limited by the used memory and is unlimited when using FIFO mode.

### ABA mode

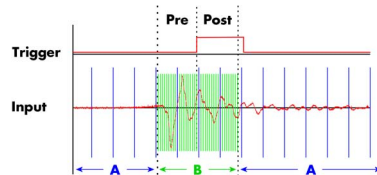

The ABA mode combines slow continuous data recording with fast acquisition on trigger events. The ABA mode works like a slow data logger combined with a fast digitizer. The exact

position of the trigger events is stored as timestamps in an extra memory.

### Timestamp

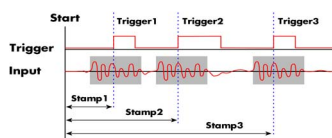

The timestamp function writes the time positions of the trigger events in an extra memory. The timestamps are relative to the start of recording, a defined zero time, externally

synchronized to a radio clock, an IIRIG-B or a GPS receiver. Using the external synchronization gives a precise time relation for acquisitions of systems on different locations.

### Firmware Option Block Average

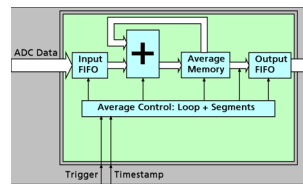

The Block Average Module improves the fidelity of noisy repetitive signals. Multiple repetitive acquisitions with very small dead-time are accumulated and averaged. Random noise is reduced by the averaging process improving the visibility of the repetitive signal. The complete averaging process is done inside the FPGA of the digitizer generating no CPU load at all. The amount of data is greatly decreased as well as the needed transfer bandwidth is heavily reduced.

Please see separate data sheet for details on the firmware option.

### Firmware Option Block Statistics (Peak Detect)

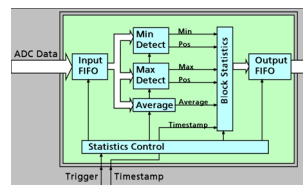

The Block Statistics and Peak Detect Module implements a widely used data analysis and reduction technology in hardware. Each block is scanned for minimum and maximum peak and a summary including minimum, maximum, average, timestamps and position information is stored in memory. The complete averaging process is done inside the FPGA of the digitizer generating no CPU load at all. The amount of data is greatly decreased as well as the needed transfer bandwidth is heavily reduced.

Please see separate data sheet for details on the firmware option.

### External clock input and output

Using a dedicated connector a sampling clock can be fed in from an external system. Additionally it's also possible to output the internally used sampling clock on a separate connector to synchronize external equipment to this clock.

### Reference clock

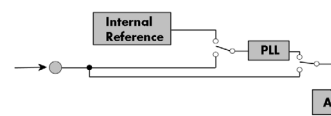

The option to use a precise external reference clock (normally 10 MHz) is necessary to synchronize the instrument for high-quality measurements with external equipment (like a signal source). It's also possible to enhance the quality of the sampling clock in this way. The driver automatically generates the requested sampling clock from the fed in reference clock.

### PXIe bus

The PXI Express bus (PCI Express extension for instrumentation) offers a variety of additional normed possibilities for synchronising different components in one system. It is possible to connect several Spectrum cards with each other as well as to connect a Spectrum card with cards of other manufacturers.

### PXI reference clock

The card is able to use the 100 MHz low-jitter reference clock that is supplied by the PXIe system. Enabled by software the PXIe reference clock is fed into the on-board PLL. This feature allows the cards to run with a fixed phase relation.

### PXI trigger

The Spectrum cards support star trigger as well as the PXI trigger bus. Using a simple software command one or more trigger lines can be used as trigger source. This feature allows the easy setup of OR connected triggers from different cards.

## **External Amplifiers**



For the acquisition of extremely small voltage levels with a high bandwidth a series of external amplifiers is available. Each of the one channel amplifiers is working with a fixed input impedance and allows - depending on the bandwidth - to select different amplification levels between  $\times 10$  (20 dB) up to

$\times 1000$  (60 dB). Using the external amplifiers of the SPA series voltage levels in the  $\mu\text{V}$  and  $\text{mV}$  area can be acquired.

## Technical Data

### Analog Inputs

Resolution		8 Bit
Input Type		Single-ended
ADC Differential non linearity (DNL)	ADC only	±0.35 LSB
ADC Integral non linearity (INL)	ADC only	±0.9 LSB
ADC Bit Error Rate (BER)	sampling rate 1.25 GS/s	10 <sup>-16</sup>
Channel selection	software programmable	1, 2, or 4 (maximum is model dependent)
Analog Input impedance	fixed	50 Ω
Input Ranges (standard ranges)	software programmable	±200 mV, ±500 mV, ±1 V, ±2.5 V (programmable input offset at 0%)
Input Ranges (Low Voltage Option)	software programmable	±40 mV, ±100 mV, ±200 mV, ±500 mV (programmable input offset at 0%)
Programmable Input Offset	software programmable	±200% (allowing bi-polar ranges to become uni-polar)
Input Coupling	software programmable	AC/DC
Max DC voltage if AC coupling active		±30 V
Offset error (full speed)	after warm-up and calibration	< 0.5 LSB
Gain error (full speed)	after warm-up and calibration	< 2.0 LSB
Crosstalk 20 MHz sine signal (standard ranges)	≥ ±500 mV standard range	< -96 dB (all channel same input range)
Crosstalk 20 MHz sine signal (standard ranges)	= ±200 mV standard range	< -88 dB (all channel same input range)
Crosstalk 100 MHz sine signal (standard ranges)	≥ ±500 mV standard range	< -78 dB (all channel same input range)
Crosstalk 100 MHz sine signal (standard ranges)	= ±200 mV standard range	< -65 dB (all channel same input range)
Over voltage protection	input range (standard ranges)	±200 mV   ±500 mV   ±1 V   ±2.5 V
	input range (low voltage option)	±40 mV   ±100 mV   ±200 mV   ±500 mV
	max. continuous input power	22.5 dBm   27.0 dBm   27.0 dBm   27.0 dBm
	max. peak input voltage	±3 V   ±7.5 V   ±15 V   ±30 V

### Trigger

Available trigger modes	software programmable	Channel Trigger, External, Software, Window, Re-Arm, Or/And, Delay
Trigger level resolution	software programmable	8 bit
Trigger edge	software programmable	Rising edge, falling edge or both edges
Trigger delay	software programmable	0 to (8GSamples - 32) = 8589934560 Samples in steps of 32 samples
Multi, ABA, Gate: re-arming time	1.25 GS/s or below 2.5 GS/s 5 GS/s	80 samples (+ programmed pretrigger) 160 samples (+ programmed pretrigger) 320 samples (+ programmed pretrigger)
Pretrigger at Multi, ABA, Gate, FIFO	software programmable	32 up to 8192 Samples in steps of 32
Posttrigger	software programmable	32 up to 16G samples in steps of 32 (defining pretrigger in standard scope mode)
Memory depth	software programmable	64 up to [installed memory / number of active channels] samples in steps of 32
Multiple Recording/ABA segment size	software programmable	64 up to [installed memory / 2 / active channels] samples in steps of 32
Internal/External trigger accuracy		1 sample
Minimum external trigger pulse width		≥ 2 samples
External trigger		<b>Ext0</b>
External trigger impedance	software programmable	50 Ω / 1 kΩ
External trigger coupling	software programmable	AC or DC
External trigger type		Window comparator
External input level		±10 V (1 kΩ), ±2.5 V (50 Ω), 2.5% of full scale range
External trigger sensitivity (minimum required signal swing)		2.5% of full scale range = 0.5 V
External trigger level	software programmable	±10 V in steps of 1 mV
External trigger maximum voltage		±30V
External trigger bandwidth DC	50 Ω / 1 kΩ	DC to 200 MHz / 150 MHz
External trigger bandwidth AC	50 Ω	20 kHz to 200 MHz
		<b>Ext1</b>
		1 kΩ
		fixed DC
		Single level comparator
		±10 V
		±10 V in steps of 1 mV
		±30 V
		DC to 200 MHz
		n.a.

### Clock

Clock Modes	software programmable	internal PLL, external reference clock, sync
Internal clock accuracy		≤ ±20 ppm
Internal clock setup granularity		divider: maximum sampling rate divided by: 1, 2, 4, 8, 16, ... up to 262144
External reference clock range	software programmable	≥ 10 MHz and ≤ 1.25 GHz
External reference clock input impedance	software programmable	50 Ω fixed
External reference clock input coupling		AC coupling
External reference clock input edge		Rising edge
External reference clock input type		Single-ended, sine wave or square wave
External reference clock input swing		0.3 V peak-peak up to 3.0 V peak-peak
External reference clock input max DC voltage		±30 V (with max 3.0 V difference between low and high level)
External reference clock input duty cycle requirement		45% to 55%
Clock setup granularity when using reference clock		divider: maximum sampling rate divided by: 1, 2, 4, 8, 16, ... up to 262144
Internal reference clock output type		Single-ended, 3.3V LVPECL
Internal reference clock output frequency		2.5 GHz / 64 = 39.0625 MHz
Star-Hub synchronization clock modes	software selectable	Internal clock (standard clock mode only), External reference clock
ABA mode clock divider for slow clock	software programmable	16 up to (128k - 16) in steps of 16
Channel to channel skew on one card		< 60 ps (typical)
Skew between star-hub synchronized cards		< 130 ps (typical, preliminary)

	M4i.223x DN2.223-xx DN2.225-xx DN6.225-xx	M4i.222x DN2.222-xx	M4i.221x DN2.221-xx DN6.221-xx	All versions
Input Ranges	Standard Ranges	Standard Ranges	Standard Ranges	Low Voltage Ranges
ADC Resolution	8 bit	8 bit	8 bit	8 bit
max internal/external clock	5 GS/s	2.5 GS/s	1.25 GS/s	model dependant
min internal clock	4.768 kS/s	4.768 kS/s	4.768 kS/s	4.768 kS/s
lower bandwidth limit (DC coupling)	0 Hz	0 Hz	0 Hz	0 Hz
lower bandwidth limit (AC coupling)	< 30 kHz	< 30 kHz	< 30 kHz	< 30 kHz
-3 dB bandwidth (no filter active)	1.5 GHz	1.5 GHz	500 MHz	700 MHz
-3 dB bandwidth (BW filter active)	~400 MHz	~400 MHz	~370 MHz	~380 MHz

### Block Average Signal Processing Option M4i.22xx/DN2.22x/DN6.22x Series

		Firmware ≥ V1.14 (August 2015)		Firmware < V1.14
Data Mode	software programmable	32 bit mode	16 bit mode	32 bit mode only
Minimum Waveform Length		64 samples	128 samples	64 samples
Minimum Waveform Stepsize		32 samples	64 samples	32 samples
Maximum Waveform Length	1 channel active	64 kSamples	128 kSamples	32 kSamples
Maximum Waveform Length	2 channels active	32 kSamples	64 kSamples	16 kSamples
Maximum Waveform Length	4 or more channels active	16 kSamples	32 kSamples	8 kSamples
Minimum Number of Averages		2	2	4
Maximum Number of Averages		16777216 (16M)	256	16777216 (16M)
Data Output Format	fixed	32 bit signed integer	16 bit signed integer	32 bit signed integer
Re-Arming Time between waveforms	1.25 GS/s or below	80 samples (+ programmed pretrigger)	80 samples (+ programmed pretrigger)	80 samples (+ programmed pretrigger)
Re-Arming Time between waveforms	2.5 GS/s	160 samples (+ programmed pretrigger)	160 samples (+ programmed pretrigger)	160 samples (+ programmed pretrigger)
Re-Arming Time between waveforms	5 GS/s	320 samples (+ programmed pretrigger)	320 samples (+ programmed pretrigger)	320 samples (+ programmed pretrigger)
Re-Arming Time between end of average to start of next average		Depending on programmed segment length, max 50 µs		80/160&320 samples as above listed

### Block Statistics Signal Processing Option M4i.22xx/DN2.22x Series/DN6.22x Series

Minimum Waveform Length		64 samples
Minimum Waveform Stepsize		32 samples
Maximum Waveform Length	Standard Acquisition	2 GSamples / channels
Maximum Waveform Length	FIFO Acquisition	2 GSamples
Data Output Format	fixed	32 bytes statistics summary
Statistics Information Set per Waveform		Average, Minimum, Maximum, Position Minimum, Position Maximum, Trigger Timestamp
Re-Arming Time between Segments	1.25 GS/s or below	80 samples (+ programmed pretrigger)
Re-Arming Time between Segments	2.5 GS/s	160 samples (+ programmed pretrigger)
Re-Arming Time between Segments	5 GS/s	320 samples (+ programmed pretrigger)

### Multi Purpose I/O lines (front-plate)

Number of multi purpose lines		three, named X0, X1, X2
Input: available signal types	software programmable	Asynchronous Digital-In, Synchronous Digital-In, Timestamp Reference Clock
Input: impedance		10 kΩ to 3.3 V
Input: maximum voltage level		-0.5 V to +4.0 V
Input: signal levels		3.3 V LVTTTL
Output: available signal types	software programmable	Asynchronous Digital-Out, Trigger Output, Run, Arm, PLL Refclock, System Clock
Output: impedance		50 Ω
Output: signal levels		3.3 V LVTTTL
Output: type		3.3V LVTTTL, TTL compatible for high impedance loads
Output: drive strength		Capable of driving 50 Ω loads, maximum drive strength ±48 mA
Output: update rate	14bit, 16 bit ADC resolution	sampling clock
Output: update rate	8 bit ADC resolution	Current sampling clock ≤ 1.25 GS/s : sampling clock Current sampling clock > 1.25 GS/s and ≤ 2.50 GS/s : ½ sampling clock Current sampling clock > 2.50 GS/s and ≤ 5.00 GS/s : ¼ sampling clock



<b>M4i.221x, M4x.221x and DN2.221-xx, 8 Bit 1.25 GS/s - low voltage input ranges</b>				
Input Path	DC or AC coupled, fixed 50 Ohm			
SINAD/THD+N (typ) (dB)	>44.0 dB	>44.8 dB	>44.8 dB	>44.8 dB
ENOB based on SINAD (bit)	>7.0 bit	>7.2 bit	>7.2 bit	>7.2 bit
ENOB based on SNR (bit)	>7.0 bit	>7.2 bit	>7.2 bit	>7.2 bit

Dynamic parameters are measured at  $\pm 1$  V input range (if no other range is stated) and 50 Ohm termination with the samplerate specified in the table. Measured parameters are averaged 20 times to get typical values. Test signal is a pure sine wave of the specified frequency with > 99% amplitude. SNR and RMS noise parameters may differ depending on the quality of the used PC. SNR = Signal to Noise Ratio, THD = Total Harmonic Distortion, SFDR = Spurious Free Dynamic Range, SINAD = Signal Noise and Distortion, ENOB = Effective Number of Bits. For a detailed description please see application note 002.

### Connectors

Analog Inputs/Analog Outputs	SMA female (one for each single-ended input)	Cable-Type: Cab-3mA-xx-xx
Trigger 0 Input	SMA female	Cable-Type: Cab-3mA-xx-xx
Clock Input	SMA female	Cable-Type: Cab-3mA-xx-xx
Trigger 1 Input	SMA female	Cable-Type: Cab-3mA-xx-xx
Clock Output	SMA female	Cable-Type: Cab-3mA-xx-xx
Multi Purpose I/O	MMCX female (3 lines)	Cable-Type: Cab-1m-xx-xx

### Environmental and Physical Details

Dimension (Single Card)	(PCB only)	160 mm x 100 mm (Standard 3U)
Width		2 slots
Weight (M4x.44xx series)	maximum	TBD
Weight (M4x.22xx, M4x.66xx series)	maximum	TBD
Warm up time		10 minutes
Operating temperature		0°C to 50°C
Storage temperature		-10°C to 70°C
Humidity		10% to 90%

### PXI Express specific details

PXIe slot type	4 Lanes, PCIe Gen 2 (x4 Gen2)
PXIe hybrid slot compatibility	Fully compatible

### Certification, Compliance, Warranty

EMC Immunity	Compliant with CE Mark
EMC Emission	Compliant with CE Mark
Product warranty	2 years starting with the day of delivery
Software and firmware updates	Life-time, free of charge

### Power Consumption

	PCI EXPRESS		
	3.3V	12 V	Total
M4x.2230-x4, M4x.2220-x4, M4x.2210-x4	0.2 A	TBD	TBD
M4x.2233-x4, M4x.2221-x4, M4x.2223-x4, M4x.2211-x4	0.2 A	TBD	TBD
M4x.2234-x4, M4x.2212-x4	0.2 A	TBD	TBD

### MTBF

MTBF	TBD
------	-----



# Hardware block diagram

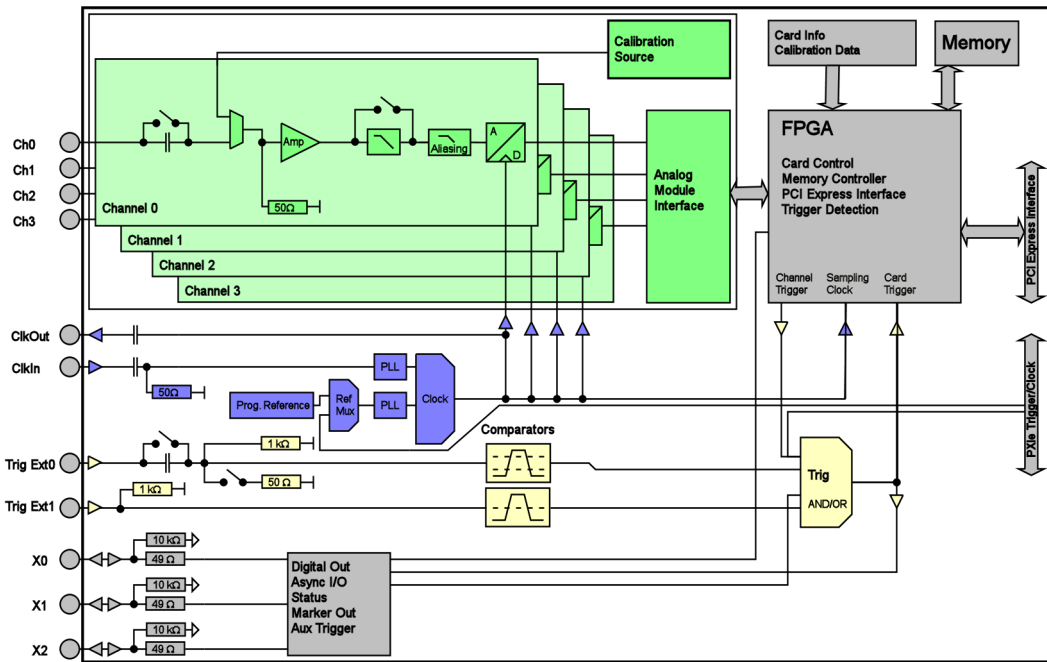

## Order Information

The card is delivered with 4 GSample on-board memory and supports standard acquisition (Scope), FIFO acquisition (streaming), Multiple Recording, Gated Sampling, ABA mode and Timestamps. Operating system drivers for Windows/Linux 32 bit and 64 bit, examples for C/C++, LabVIEW (Windows), MATLAB (Windows and Linux), LabWindows/CVI, IVI, .NET, Delphi, Visual Basic, Python and a Base license of the oscilloscope software SBench 6 are included. Drivers for other 3rd party products like VEE or DASYLab may be available on request.

**Adapter cables are not included. Please order separately!**

### PXI Express x4

Order no.	Bandwidth	Standard mem	1 channel	2 channels	4 channels
M4x.2210-x4	500 MHz	4 GSample	1.25 GS/s		
M4x.2211-x4	500 MHz	4 GSample	1.25 GS/s	1.25 GS/s	
M4x.2212-x4	500 MHz	4 GSample	1.25 GS/s	1.25 GS/s	1.25 GS/s
M4x.2220-x4	1.5 GHz	4 GSample	2.5 GS/s		
M4x.2223-x4	1.5 GHz	4 GSample	2.5 GS/s	1.25 GS/s	
M4x.2221-x4	1.5 GHz	4 GSample	2.5 GS/s	2.5 GS/s	
M4x.2230-x4	1.5 GHz	4 GSample	5 GS/s		
M4x.2233-x4	1.5 GHz	4 GSample	5 GS/s	2.5 GS/s	
M4x.2234-x4	1.5 GHz	4 GSample	5 GS/s	2.5 GS/s	1.25 GS/s

### Options

Order no.	Option
M4i.22xx-ir40m	Low voltage input range option for 22xx series. 4 Input ranges with $\pm 40$ mV, $\pm 100$ mV, $\pm 200$ mV, $\pm 500$ mV, bandwidth limited to 700 MHz

### Firmware Options

Order no.	Option
M4i.xxxx-spavg	Signal Processing Firmware Option: Block Average (later installation by firmware - upgrade available)
M4i.xxxx-spstat	Signal Processing Firmware Option: Block Statistics/Peak Detect (later installation by firmware - upgrade available)

### Services

Order no.	
WarrExt5	Warranty extension from 2 years standard warranty to 5 years
Recal	Recalibration at Spectrum incl. calibration protocol

### Standard Cables

for Connections	Length	Order no.				
		to BNC male	to BNC female	to SMA male	to SMA female	to SMB female
Analog/Clock-In/Trig-In	80 cm	Cab-3mA-9m-80	Cab-3mA-9f-80			
Analog/Clock-In/Trig-In	200 cm	Cab-3mA-9m-200	Cab-3mA-9f-200			
Probes (short)	5 cm		Cab-3mA-9f-5			
Clk-Out/Trig-Out/Extra	80 cm	Cab-1m-9m-80	Cab-1m-9f-80	Cab-1m-3mA-80	Cab-1m-3fA-80	Cab-1m-3f-80
Clk-Out/Trig-Out/Extra	200 cm	Cab-1m-9m-200	Cab-1m-9f-200	Cab-1m-3mA-200	Cab-1m-3fA-200	Cab-1m-3f-200
Information	The standard adapter cables are based on RG174 cables and have a nominal attenuation of 0.3 dB/m at 100 MHz and 0.5 dB/m at 250 MHz. For high speed signals we recommend the low loss cables series CHF					

### Low Loss Cables

Order No.	Option
CHF-3mA-3mA-200	Low loss cables SMA male to SMA male 200 cm
CHF-3mA-9m-200	Low loss cables SMA male to BNC male 200 cm
Information	The low loss adapter cables are based on MF141 cables and have an attenuation of 0.3 dB/m at 500 MHz and 0.5 dB/m at 1.5 GHz. They are recommended for signal frequencies of 200 MHz and above.

### Amplifiers

Order no.	Bandwidth	Connection	Input Impedance	Coupling	Amplification
SPA.1841 (2)	2 GHz	SMA	50 Ohm	AC	x100 (40 dB)
SPA.1801 (2)	2 GHz	SMA	50 Ohm	AC	x10 (20 dB)
SPA.1601 (2)	500 MHz	BNC	50 Ohm	DC	x10 (20 dB)
Information	External Amplifiers with one channel, BNC/SMA female connections on input and output, manually adjustable offset, manually switchable settings. An external power supply for 100 to 240 VAC is included. Please be sure to order an adapter cable matching the amplifier connector type and matching the connector type for your A/D card input.				

### Software SBench6

Order no.	
SBench6	Base version included in delivery. Supports standard mode for one card.
SBench6-Pro	Professional version for one card: FIFO mode, export/import, calculation functions
SBench6-Multi	Option multiple cards: Needs SBench6-Pro. Handles multiple synchronized cards in one system.
Volume Licenses	Please ask Spectrum for details.

### Software Options

Order no.	
Spc-RServer	Remote Server Software Package - LAN remote access for M2i/M3i/M4i/M4x cards

(1) : Just one of the options can be installed on a card at a time.

(2) : Third party product with warranty differing from our export conditions. No volume rebate possible.

#### Technical changes and printing errors possible

SBench, digitizerNETBOX and generatorNETBOX are registered trademarks of Spectrum Systementwicklung Microelectronic GmbH. Microsoft, Visual C++, Visual Basic, Windows, Windows 98, Windows NT, Window 2000, Windows XP, Windows Vista, Windows 7, Windows 8 and Windows 10 are trademarks/registered trademarks of Microsoft Corporation. LabVIEW, DASYLab, Diadem and LabWindows/CVI are trademarks/registered trademarks of National Instruments Corporation. MATLAB is a trademark/registered trademark of The Mathworks, Inc. Keysight VEE, VEE Pro and VEE OneLab are trademarks/registered trademarks of Keysight Technologies, Inc. FlexPro is a registered trademark of Weisang GmbH & Co. KG. PCIe, PCI Express and PCI-X are trademarks of PCI-SIG. LXI is a registered trademark of the LXI Consortium.